

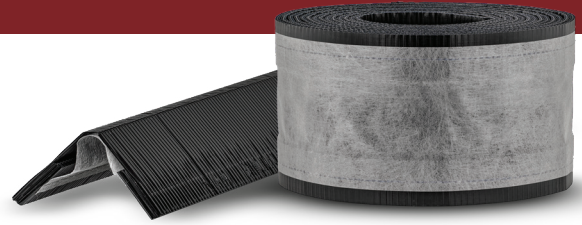

StormStop[®]

RIDGE VENT



The amount of ventilation is controlled by the length of slot cut along the roof ridge. For the most attractive roofline, it is recommended that CraftGrade StormStop Ridge Vent Rolls or Sections be installed along the entire ridge of the roof.

1. Ridge Ventilation Slot Preparation



The slot may be pre-cut on a new roof before or after shingle installation or in a retrofit, the slot can be cut

from the pre-shingled roof using a circular saw with a carbide tip blade (protective eye goggles should be worn during this process). For CraftGrade

StormStop Ridge Vents with $\frac{5}{8}$ " profile, cut a 2" slot (1" on each side of ridge) along the ridge(s). For a roof with a center beam, a $3\frac{1}{2}$ " slot should be cut ($1\frac{3}{4}$ " on each side of ridge). For StormStop Section vents with 1" profile, cut a $2\frac{1}{2}$ " slot ($1\frac{1}{4}$ " on each side ridge). For center beam applications a 4" slot should be cut (2" on each side of ridge). A minimum of 6" must be left uncut on each end of the ridge. Once the slot is cut and any overlapping shingles covering the ridge are trimmed and removed, the ridge is ready for vent installation.

2. End Cap Installation

Pull apart a pre-cut section of the foam end cap found with the vent. Using a utility knife, make a cut in the StormStop material $\frac{1}{2}$ " on each side, back from the end of the section. Using construction adhesive or sealant caulk, coat both sides of the StormStop material where it has been cut back at the end of the vent. Insert the foam end cap with the cut-back StormStop material between the foam end cap and the underside of the vent to assure a weather-tight seal. Sealant must be applied to roof shingles before installing vent. See Step 3 for approved sealants.





3. Vent Placement on Ridge

Attach vent to the roof deck by driving a nail in each of the two corners on both ends of the vent. Also, drive two nails through the vent and foam end cap to hold foam in place on the ends of the ridge only. Nails should penetrate the wood roof deck at least $\frac{3}{4}$ ". It is not recommended to nail vent to ridge prior to cap shingle installation. When installing over architectural shingles or roofs with a slope of less than 5/12, apply a bead of sealant on the roof shingles beneath the vent before securing the vent down.

This sealant should fill any voids between the bottom of the vent and the surface of the shingle. Use either butyl sealant conforming to ASTM C1085, latex sealant conforming to ASTM C834, silicone sealant complying with ASTM C920 or asphalt roofing cement complying with ASTM D4586. Roll out or place CraftGrade Ridge Vent along the entire length of slot also covering the 6" minimum uncut ridge on both ends. Bend vent into a "V" Shape. Secure at the lead edge after inserting the end cap.

Nail should penetrate roof deck a minimum of $\frac{3}{4}$ ". Pull the vent tight and secure at about 10'. Pull the rest of the vent tight and secure, inserting the end cap. Multiple lengths of vent can be joined by butting the sections tightly together. End caps should be inserted at the beginning and end of each section. Do not pre-fasten ridge vent along the entire vent; with CraftGrade Ridge Vent's One-Pass™ Installation, it is not necessary to pre-fasten the vent every 2' to 3' prior to cap shingle installation.





3b. Note: For “Class A” Installation Only

For “Class A” CraftGrade StormStop Ridge Vent installation, follow steps 1, 2, 3 as stated above. Once the vent has been installed, use a utility knife with a hook blade and remove the corrugated plastic center section of the vent. Do this for the hip and ridge. This modified installation meets the requirements for UL790 “Class A”; standard installation meets the requirements for UL790 “Class C.” Continue to Step 4.

4. Cap Shingle Installation

Using One-Pass Installation secure cap shingles and vent at the same time. Nail ridge caps with roofing nails in a common, overlapping pattern. Nails should penetrate the wood roof deck at least 3/4”.

For the fastest installation, a coil nail gun can be used as long as the minimum penetration is 3/4”. It is important when installing this vent that you maintain the pitch of the roof. The vent has been installed properly if the bottom of the vent is flat on the roof and the peak is slightly rounded.

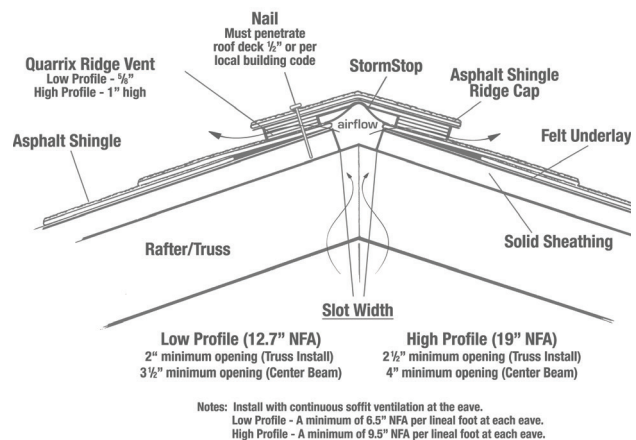

Description: consult oretimi linam. Verehena, non tam reste non tus is



StormStop®
RIDGE VENT

HipRoofs

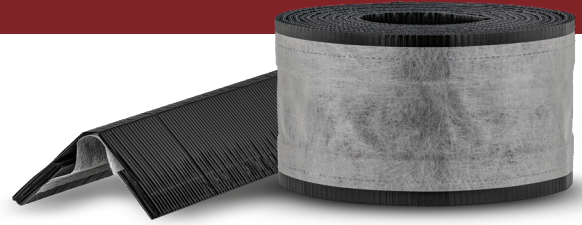

1. Hip and Ridge Ventilation Slot Preparation

Determine how long of a hip and ridge ventilation slot will be required according to 1:300 rule. The ridge and hip ventilation slot may be pre-cut on a new roof before or after shingle installation or in a retrofit, the slot can be cut from the pre-shingled roof using a circular saw with a carbide tip blade (protective eye goggles should be worn during this process). Start ridge ventilation slot 6" from point where hip and ridge meet. For 5/8" profile vents, cut a 2" slot (1" on each side of ridge) along the ridge(s). For a roof with a center beam, a 3 1/2" slot should be cut (1 3/4" on each side of ridge). For 1" profile vents, cut a 2 1/2" slot (1 1/4" on each side of ridge). For center beam applications a 4" slot should be cut (2" on each side of ridge). If entire ridge requires ventilation, stop ventilation slot 6" from point where hip and ridge meet. To maintain structural integrity, one continuous slot is not recommended on hip applications. Start ventilation preparation by leaving 6" of hip uncut from where the ridge and hip meet. Cut a 3/2" wide slot for ventilation. Hip slot should be 18" in length, spaced with a 12" uncut area between each 18" opening. The slot for ventilation should not be cut any lower than the top 1/3 of the roof to maintain a balanced ventilation system.

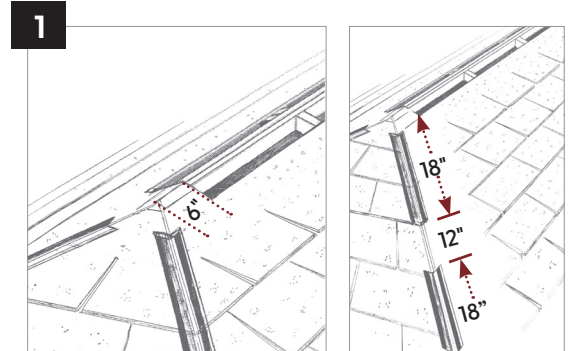

2. End Cap Installation

Pull apart a pre-cut section of the foam end cap found with the vent. Using a utility knife, make a cut in the StormStop material 1/2" on each side, back from the end of the section. Using construction adhesive or sealant caulk, coat both sides of the StormStop material where it has been cut back at the end of the vent. Insert the foam end cap with the cut-back StormStop material between the foam end cap and the underside of the vent to assure a weather-tight seal. Because of the popularity of dimensional roofing material such as 40/50 year and lifetime laminated shingles we require that a bead of sealant be applied to the roof shingles before installing the vent on the ridge. This sealant should fill any voids between the bottom of the vent and the surface of the shingle. Use either butyl sealant conforming to ASTM C1085, latex sealant conforming to ASTM C834, silicon sealant complying with ASTM C 920 or asphalt roofing cement complying with ASTM D4586.

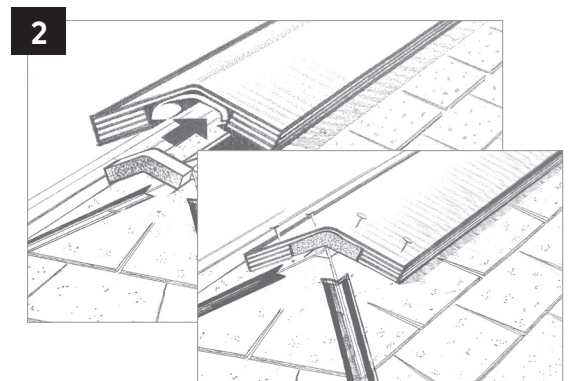

3. Vent Placement on Ridge

Attach vent to the roof deck by driving a nail in each of the two corners on both ends of the vent. Also, drive two nails through the vent and foam end cap to hold foam in place on the ends of the ridge only. Nails should penetrate to cap shingle installation. Because of the popularity of dimensional roofing material such as the newer 40/50 year and lifetime laminated shingles we require that a bead of sealant be applied to the roof shingles, before installing the vent on the ridge. See step 2 for recommended sealants.

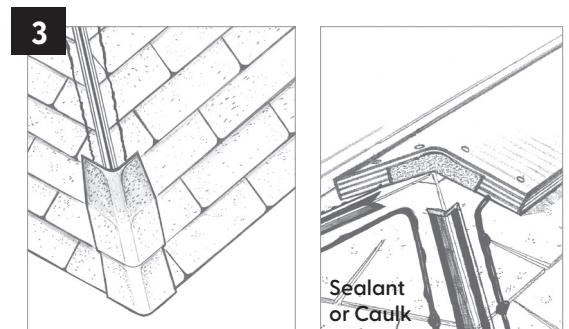



HipRoofs

3b

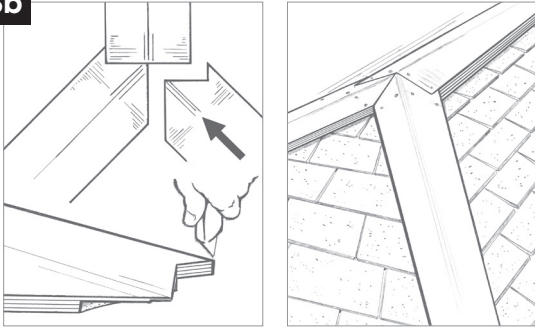

(Vent Placement On Ridge Continued) Roll out or place vent along the entire length of slot also covering the 6" minimum uncut ridge on both ends. When using R-Series (Rigid Roll) products, secure at the lead edge after inserting the end cap. Shape vent in V Shape. Pull the vent tight and secure at about 10 feet. Pull the rest of the vent tight and secure, inserting the end cap. Multiple lengths of vent can be joined by butting the sections tightly together. End cap should be inserted at the beginning and end of each section.

4

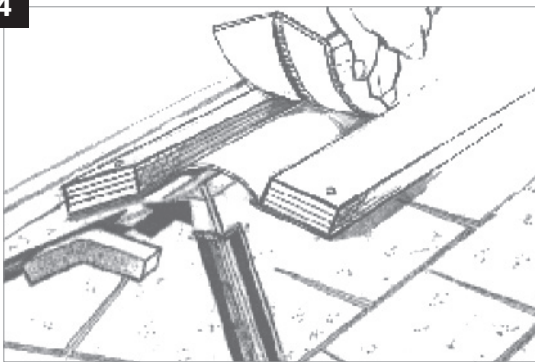

4. Vent Placement on Hip

Install a minimum of 2 cap shingles at the bottom of the hip. If the vent is not being run the entire length of the hip, the vent should overlap a minimum of 2 cap shingles at the end of the vent. Before installing the vent on the hip, lay a bead of sealant on each side of the pre-cut slots. This will create a seal on the step created by overlapping pattern of the shingles. The bead of sealant should be applied approximately 1" from the edge of the pre-cut slot.

Note: For "Class A" Installation Only

For "Class A" CraftGrade vent installation, follow steps 1, 2, 3 as stated above. Once the vent has been installed, use a utility knife with a hook blade and remove the corrugated plastic center section of the vent. Do this for the hip and ridge. This modified installation meets the requirements for UL790 "Class A"; standard installation meets the requirements for UL790 "Class C." Follow remaining steps 4, 5, 6 as stated.

5

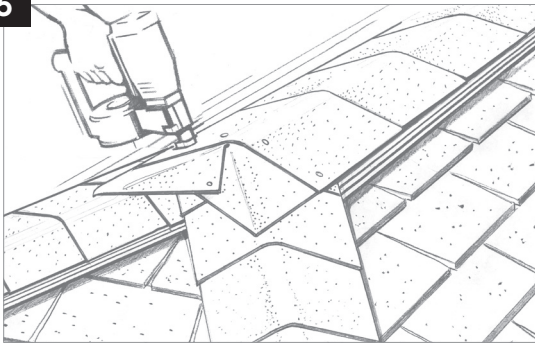

5. Hip and Ridge Vent Transition

Using a utility knife, trim the end of the vent from the hip to the ridge. This creates the most attractive ridge and hip line. Insert the foam end cap under the ridge vent where it is at full width. Fasten vent for hip at point where it meets ridge. Roll out or place the vent all of the way down the hip, covering 2 pre-laid cap shingles at the bottom of the hip. Go back over hip vents and fasten at 4" intervals. If the vent is not being run the entire length of the hip, use the cap shingles to create a transition. Use sealant to fill any void left between the shingles and the remaining top layer of the vent. Be sure to apply roofing sealant to any spaces left by cap shingle used for transition. If 2 or more sections of ridge vent are being joined together, an end cap MUST be installed into each end of the joining sections. Repeat on all hips.

6

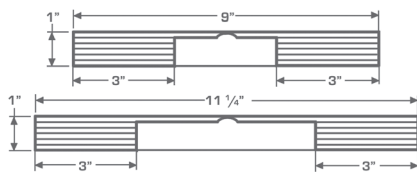

CraftGrade Ridge Vents High Profile - End Views

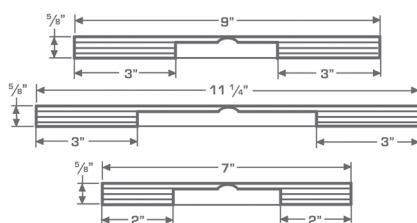

CraftGrade Ridge Vents Low Profile - End Views

6. Cap Shingle Installation

Apply the cap shingles to the hip and then to the ridge. Nail hip and ridge caps with roofing nails in a common overlapping pattern. Nails should penetrate the wood roof deck at least 3/4". For fastest installation, a coil nail gun can be used as long as the minimum 3/4" penetration into the deck is maintained. It is important when installing this vent that you maintain the pitch of the roof. The vent has been installed properly if the bottom of the vent is flat on the roof and the peak is slightly rounded.



StormStop[®]
RIDGE VENT

STONE-COATED SteelRoofs

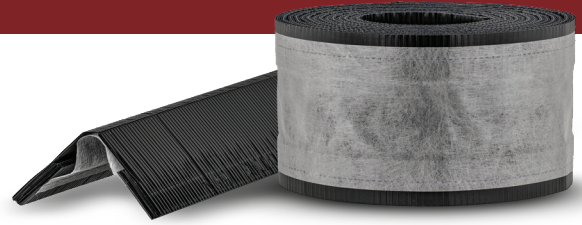

1. Ridge Ventilation Slot Preparation

Cut the slot prior to installing the last course of shingle panels along the ridge in a re-roof or new construction application (protective eye goggles should be worn during this process). For $\frac{5}{8}$ " profile 7" wide vents, cut a 2" slot (1" on each side of ridge) along the ridge. A minimum of 6" must be left uncut on each end of the ridge. Once the slot is cut then measure and cut shingle panels to fit along the ridge; panels should not obstruct the slot. Once the panels are installed, the ridge is ready for vent installation.

Retrofit with Stone-Coated Steel If stone-coated steel is already installed, the slot can be cut from the pre-paneled roof using a circular saw with a combination blade (reversed) or a Tenryu Steel Pro blade (protective eye goggles should be worn during this process). For $\frac{5}{8}$ " profile 7" wide vents, cut a 2" slot (1" on each side of ridge) along the ridge. A minimum of 6" must be left uncut on each end of the ridge.

2. End Cap Installation

Pull apart a pre-cut section of the foam end cap found with the vent, usually found in the first 3 feet of the roll. Use a utility knife to make a cut in the StormStop material $\frac{1}{2}$ " on each side, back from the end of the section (See insets). Using construction adhesive or sealant caulk, coat both sides of the StormStop material where it has been cut back at the end of the vent. Insert the foam end cap with the cut-back StormStop material between the foam end cap and the underside of the vent to assure a weather-tight seal.

3. Vent Placement on Ridge

Before installing the vent on the ridge a bead of sealant is required between the stone-coated steel and the underside of the ridge vent. This sealant should fill any voids between the bottom of the vent and the surface of the panel. Caulking and sealants shall be suitable for exterior use and be resistant to weathering; use either butyl or polyurethane sealants. The caulking and the sealants shall be compatible with and adhere to the materials to which they are applied. Check sealant manufacturer's instructions and stone coated steel's installation guide for compatibility. Roll out or place ridge vent along the entire length of slot also covering the 6" minimum uncut ridge on both ends. When using R-Series (Rigid Roll) products, secure at the lead edge, inserting the end cap. Pull the vent tight and secure at about 10 feet. Pull the rest of the vent tight and secure, inserting the end cap. Multiple lengths of vent can be joined by butting the sections tightly together. An end cap should be inserted at the end of each section.

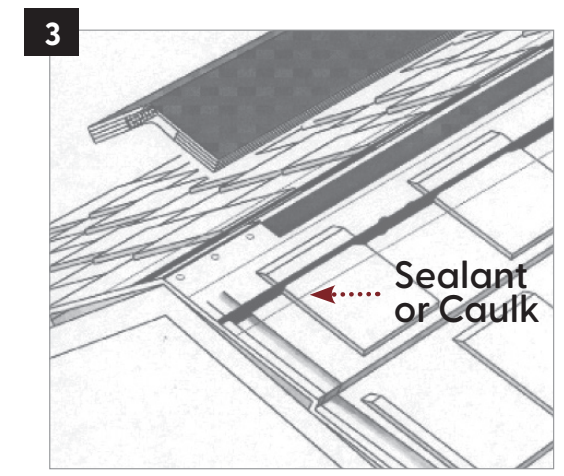
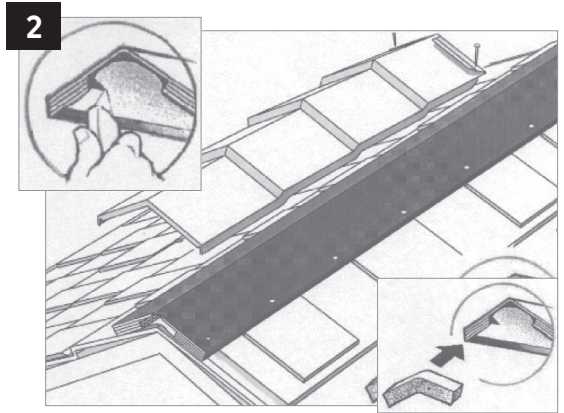
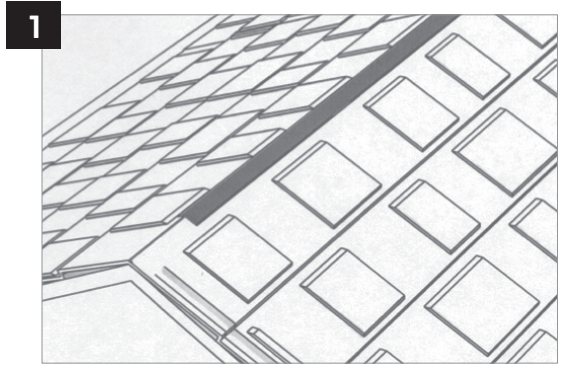



STONE-COATED SteelRoofs

Attach vent to the roof deck by driving a nail or a #8 screw in each of the two corners on both ends of the vent. Also, drive two nails or #8 screws through the vent and foam end cap to hold foam in place on the ends of the ridge only. Fasteners should penetrate the wood roof deck at least $\frac{3}{4}$ ". It is recommended to fasten the vent to ridge prior to stone-coated steel hip/ridge cap installation. Vent should be secured every 5".

4. Cap Shingle Installation

It is important when installing this vent that you maintain the pitch of the roof. The vent has been installed properly if the bottom of the vent is flat on the roof and the peak is slightly rounded. Install hip/ridge caps per manufacturer's installation guide. Each hip/ridge piece should clip together by inserting the return (at the nose of each piece) into the back clip, which is located at the top of the hip/ridge cap section. Fasten cap to vent through the back clip using #8 screws. Fasteners should penetrate through the wood roof deck at least $\frac{3}{4}$ ".

4

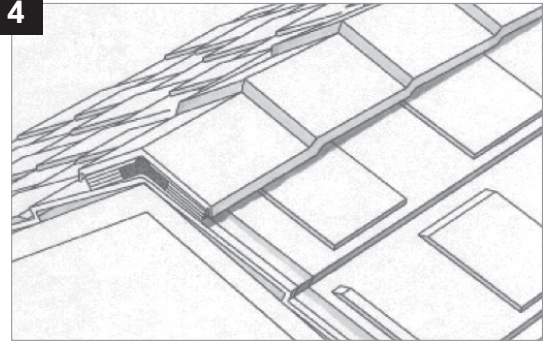



StormStop[®]
RIDGE VENT

FlatTile

ROOFS

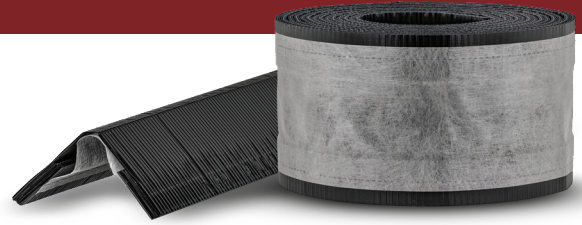

1. Ridge Ventilation Slot Preparation

The slot must be cut on a new roof before field tile installation. The amount of ventilation is controlled by the length of slot cut along the roof ridge. Remember, for the most attractive roofline, it is recommended that CraftGrade ridge vents be installed along the entire ridge of the roof. For 5/8" profile vents, a 3 1/2" slot should be cut (1 3/4" on each side of ridge). For 1" profile vents a 4" slot should be cut (2" on each side of the ridge). A minimum of 6" must be left uncut on each end of the ridge. Once the slot is cut and the battens are installed, it is time to install the field and trim tiles per the tile manufacturer's installation instructions. After field tile installation, the ridge now is ready for vent installation.

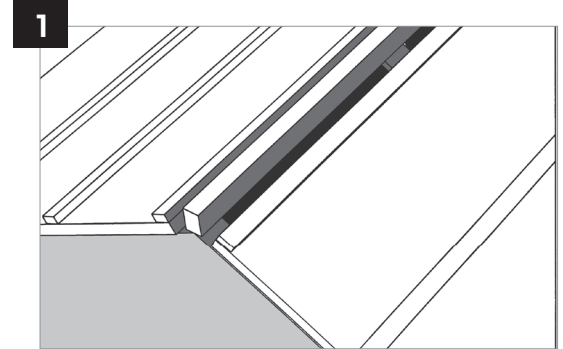

2. End Cap Installation

Pull apart a precut section of the foam end cap found with the vent. Using a utility knife, make a cut in the StormStop material 1/2" on each side of the vent, back from the end of the section. Using construction adhesive or sealant caulk, coat both sides of the StormStop material where it has been cut back at the end of the vent. Insert the foam end cap with the cut-back StormStop material between the foam end cap and the underside of the vent to assure a weather-tight seal.

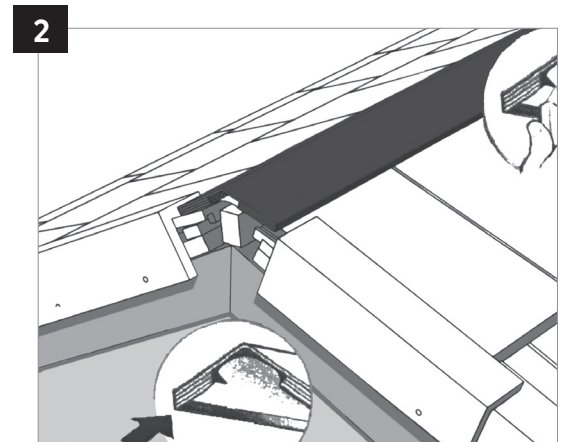

3. Vent Placement on Ridge

Before installing the vent on the ridge, a bead of sealant is required between the roof tile and the under side of the ridge vent. This sealant should fill any voids between the bottom of the vent and the surface of the tile. Caulking and sealants shall be suitable for exterior use and be resistant to weathering. The caulking and the sealants shall be compatible with and adhere to the materials to which they are applied. Check sealant manufacturer's instructions for compatibility. Roll out or place vent along the entire length of slot also covering the 6" minimum uncut ridge on both ends. Multiple lengths of vent can be joined by butting the sections tightly together. An end cap should be inserted at the end of each section.

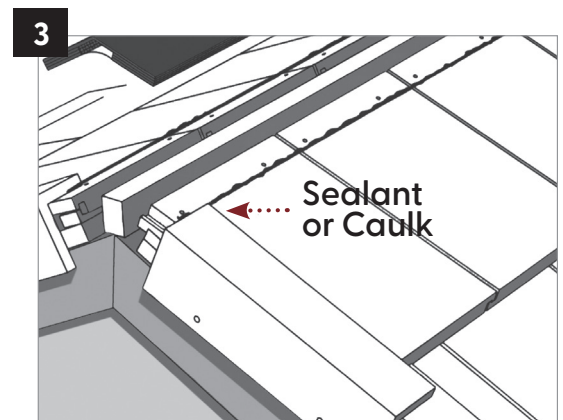



4. Cap Tile Installation

It is important when installing this vent that you maintain the pitch of the roof. The vent has been installed properly if the bottom of the vent is flat on the roof and the peak is slightly rounded. Install cap tiles per tile manufacturer's installation instructions. Ridge vent installed in this manner meet the requirement for weather blocking according to Concrete and Clay Roof Tile Design Criteria Installation Manual for Moderate Climate Regions, ICBO ER 6034P.

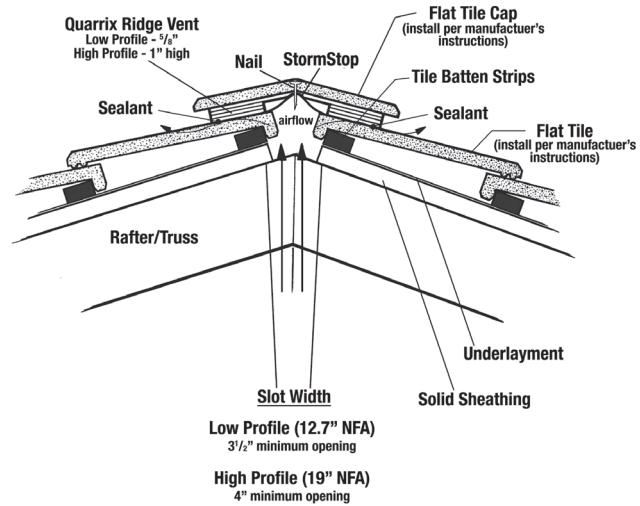
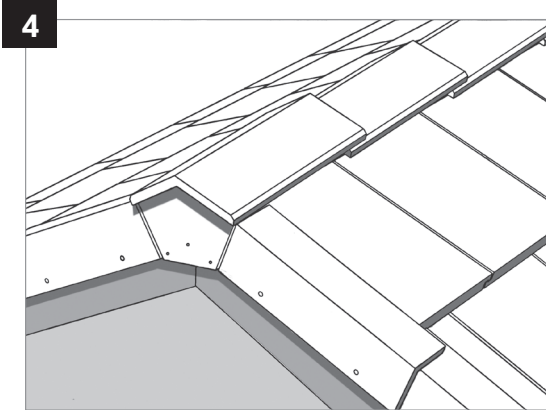

Notes: Install with continuous soffit ventilation at the eave.
 Low Profile - A minimum of 6.5" NFA per lineal foot at each eave
 High Profile - A minimum of 9.5" NFA per lineal foot at each eave



StormStop[®]
RIDGE VENT

Cedar Shake & SHINGLE ROOFS

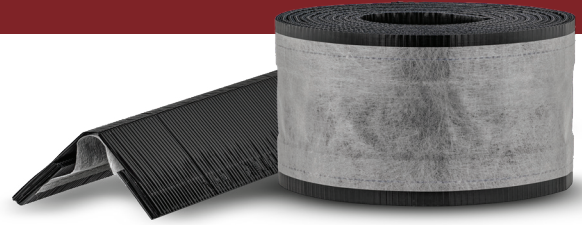

1. Ridge Ventilation Slot Preparation

The slot may be precut on a new roof before or after shake installation or in a retrofit, the slot can be cut from the roof using a circular saw with a carbide tip blade (protective eye goggles should be worn during this process). For 5/8" profile vents, cut a 2" slot (1" on each side of ridge) along the ridge(s). For a roof with a center beam, a 3/2" slot should be cut (1/4" on each side of ridge). For 1" profile vents, cut a 2 1/2" slot (1/4" on each side ridge). For center beam applications a 4" slot should be cut (2" on each side of ridge). A minimum of 6" must be left uncut on each end of the ridge.

2. End Cap Installation

Pull apart a precut section of the foam end cap found with the vent. For products with StormStop, using a utility knife, make a cut in the StormStop material 1/2" on each side, back from the end of the section. Using construction adhesive or sealant caulk, coat both sides of the StormStop material where it has been cut back at the end of the vent. Insert the foam end cap with the cut back StormStop material between the foam end cap and the underside of the vent to assure a weather-tight seal. Attach vent to the roof deck by driving a nail in each of the two corners on both ends of the vent. Also, drive two nails through the vent and foam end cap to hold foam in place on the ends of the ridge only. Nails should penetrate the wood roof deck at least 3/4". It is not recommended to nail vent to ridge prior to cap shake installation.

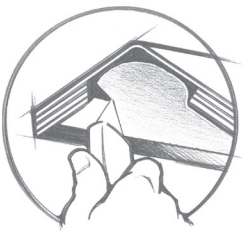

3. Vent Placement on Ridge

Before installing the vent on the ridge, apply a bead of sealant on each side of the ridge slot. This sealant should fill any voids between the bottom of the vent and the surface of the cedar shakes. Use either butyl sealant conforming to ASTM C1085; latex sealant conforming to ASTM C834; silicone sealant complying with ASTM C920 or asphalt roofing cement complying with ASTM D4586. Roll out or place vent along the entire length of slot also covering the 6" minimum uncut ridge on both ends. When using R-Series (Rigid Roll) products, secure at the lead edge with end cap. Nail should penetrate roof deck a minimum of 3/4". Pull the vent tight and secure at about 10 feet. Pull the rest of the vent tight and secure, inserting the end cap. Multiple lengths of vent can be joined by butting the sections tightly together. An end cap should be inserted at the end of each section.

Note: For "Class A" Installation Only

For "Class A" CraftGrade vent installation, follow steps 1, 2, 3 as stated above. Once the vent has been installed, use a utility knife with a hook blade and remove the corrugated plastic center section of the vent. Do this for the hip and ridge. This modified installation meets the requirements for UL790 "Class A", standard installation meets the requirements for UL790 "Class C". Follow remaining steps 4 as stated.



Cedar Shake & SHINGLE ROOFS

4. Cap Shake Installation

Secure shake caps and vent at the same time using a nail that should penetrate the wood roof deck at least $\frac{3}{4}$ ". It is important when installing this vent that you maintain the pitch of the roof.

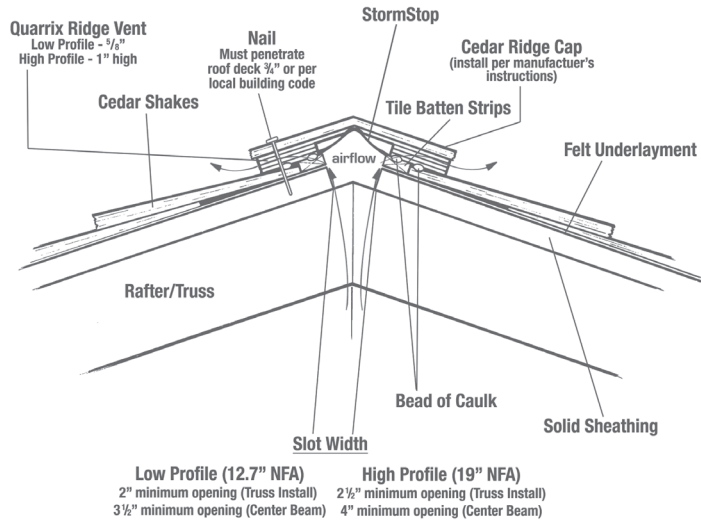



StormStop[®]
RIDGE VENT

Metal Roofs

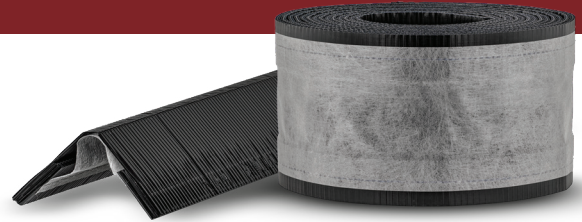

1. Ridge Ventilation Slot Preparation

Cut the slot along the ridge prior to installing metal panels in a re-roof or new construction application (protective eye goggles should be worn during this process). For $\frac{5}{8}$ " profile 9" wide vents, cut a 2" slot (1" on each side of ridge) along the ridge. A minimum of 6" must be left uncut on each end of the ridge. Once the slot is cut then measure and cut metal panels to fit along the ridge; panels should not obstruct the slot. Once the panels are installed, the ridge is ready for vent installation. Place foam closure or metal closure on each side of ridge. Install CraftGrade Ridge Vent.

Retrofit metal roofing is already installed; the slot can be cut using a circular saw with a combination blade (reversed) or a Tenryu Steel Pro blade (protective eye goggles should be worn during this process). For $\frac{5}{8}$ " profile 9" wide vents, cut a 2" slot (1" on each side of ridge) along the ridge. A minimum of 6" must be left uncut on each end of the ridge. Place foam closure or metal closure on each side of ridge. Install CraftGrade Ridge Vent.

2. End Cap Installation

Pull apart a pre-cut section of the foam end cap found with the vent, found 3 feet into the roll. Use a utility knife to make a cut in the StormStop material $\frac{1}{2}$ " on each side, back from the end of the section. Using construction adhesive or sealant caulk, coat both sides of the StormStop material where it has been cut back at the end of the vent. Insert the foam end cap with the cut-back Storm Stop material between the foam end cap and the underside of the vent to assure a weather-tight seal.

3. Vent Placement on Ridge

Before installing the ridge vent, a bead of sealant is required between the metal or foam closure and the underside of the vent, filling any voids. Caulking and sealants shall be suitable for exterior use and be resistant to weathering; use either butyl or polyurethane sealants. The caulking and the sealants shall be compatible with and adhere to the materials to which they are applied. Check sealant manufacturer's instructions and metal manufacturer's installation guide for compatibility. Roll out or place ridge vent along the entire length of slot also covering the 6" minimum uncut ridge on both ends.

When using R-Series (Rigid Roll) products, secure at the lead edge, inserting the end cap. Pull the vent tight and secure at 10 feet. Pull the rest of the vent tight and secure, inserting the end cap. Multiple lengths of vent can be joined by butting the sections tightly together. An end cap should be inserted at the end of each section. Attach vent to the roof deck metal fastener in each of the two corners on both ends of the vent. Also, drive two fasteners through the vent and foam end cap to hold foam in place on the ends of the ridge only. Fasteners should penetrate the wood roof deck at least $\frac{3}{4}$ ". It is recommended to fasten the vent to ridge prior to hip/ridge cap installation.



Metal Roofs

4. Cap Installation

It is important when installing this vent that you maintain the pitch of the roof. The vent has been installed properly if the bottom of the vent is flat on the roof and the peak is slightly rounded. Install metal ridge cap over CraftGrade Ridge Vent according to metal manufacturer's installation instructions.

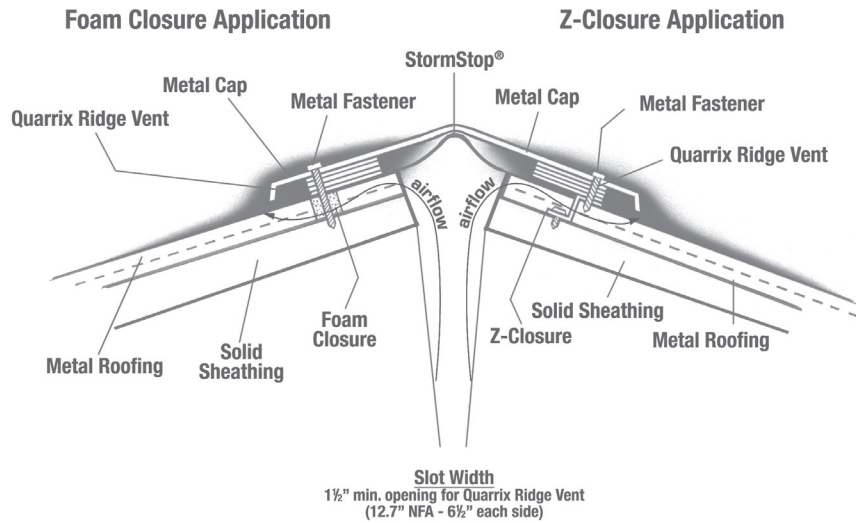

Notes: Install with continuous soffit ventilation at the eave. A minimum of 6.5" NFA per lineal foot at each eave.